

Introduction

The serial configuration devices provide the following features:

- 1-, 4-, 16-, 64-, and 128-Mbit flash memory devices that serially configure Stratix® III, Stratix II GX, and Stratix II FPGAs, Arria™ GX FPGAs, and the Cyclone® series FPGAs using the active serial (AS) configuration scheme
- Easy-to-use four-pin interface
- Low cost, low-pin count, and non-volatile memory
- Low current during configuration and near-zero standby mode current
- 2.7-V to 3.6-V operation
- EPCS1 and EPCS4 available in 8-pin small outline integrated circuit (SOIC) package. EPCS16 and EPCS128 available in 8-pin or 16-pin small outline integrated circuit (SOIC) packages
- Enables the Nios® processor to access unused flash memory through AS memory interface
- Re-programmable memory with more than 100,000 erase/program cycles
- Write protection support for memory sectors using status register bits
- In-system programming support with SRunner software driver
- In-system programming support with USB Blaster™, Ethernet Blaster™, or ByteBlaster™ II download cables
- Additional programming support with the Altera® Programming Unit (APU) and programming hardware from BP Microsystems, System General, and other vendors
- Software design support with the Altera Quartus® II development system for Windows-based PCs as well as Sun SPARC station and HP 9000 Series 700/800
- Delivered with the memory array erased (all the bits set to 1)



The term “serial configuration devices” used in this document refers to Altera EPCS1, EPCS4, EPCS16, EPCS64, and EPCS128.

Functional Description

With SRAM-based devices that support active serial configuration, configuration data must be reloaded each time the device powers up, the system reconfigures, or when new configuration data is required. Serial configuration devices are flash memory devices with a serial interface that can store configuration data for FPGA devices that support active serial configuration and reload the data to the device upon power-up or reconfiguration. [Table 4-1](#) lists the serial configuration devices.

Table 4-1. Serial Configuration Devices (3.3-V Operation)

Device	Memory Size (Bits)
EPCS1	1,048,576
EPCS4	4,194,304
EPCS16	16,777,216
EPCS64	67,108,864
EPCS128	134,217,728

For an 8-pin SOIC package, you can migrate vertically from the EPCS1 to the EPCS4 or EPCS16 since the EPCS devices are offered in the same device package. Similarly, for a 16-pin SOIC package, you can migrate vertically from the EPCS16 to the EPCS64 or EPCS128.

 EPCS16 is available in 8-pin and 16-pin SOIC packages.

[Table 4-2](#) lists the serial configuration device used with each Stratix IV FPGA and the configuration file size. For larger Stratix IV devices such as EPC4SGX290 and EP4SGX360.

Table 4-2. Serial Configuration Device Support for Stratix IV Devices

Stratix IV Device	Raw Binary File Size (Mbits) (1)	Serial Configuration Device				
		EPCS1	EPCS4	EPCS16	EPCS64	EPCS128
EP4SE110	53	—	—	—	✓	✓
EP4SE230	104	—	—	—	—	✓
EP4SE290	141	—	—	—	—	✓ (2)
EP4SE360	141	—	—	—	—	✓ (2)
EP4SE530	188	—	—	—	—	—
EP4SE680	234	—	—	—	—	—
EP4SGX70	53	—	—	—	✓	✓
EP4SGX110	53	—	—	—	✓	✓
EP4SGX230	104	—	—	—	—	✓
EP4SGX290	141	—	—	—	—	✓ (2)
EP4SGX360	141	—	—	—	—	✓ (2)
EP4SGX530	188	—	—	—	—	—

Notes to Table 4-2:

- (1) These values are preliminary. These are uncompressed file sizes.
- (2) This is with the Stratix IV compression feature enabled.

Table 4-3 lists the serial configuration device used with each Stratix III FPGA and the configuration file size. Stratix III devices can be used with EPCS16, EPCS64, or EPCS128.

Table 4-3. Serial Configuration Device Support for Stratix III Devices

Stratix III Device	Raw Binary File Size (Bits) (1)	Serial Configuration Device				
		EPCS1	EPCS4	EPCS16	EPCS64	EPCS128
EP3SL50	22,178,792	—	—	✓ (2)	✓	✓
EP3SL70	22,178,792	—	—	✓ (2)	✓	✓
EP3SL110	47,413,312	—	—	—	✓	✓
EP3SL150	47,413,312	—	—	—	✓	✓
EP3SL200	93,324,656	—	—	—	✓ (2)	✓
EP3SL340	117,384,664	—	—	—	—	✓
EP3SE50	25,891,968	—	—	—	✓	✓
EP3SE80	48,225,392	—	—	—	✓	✓
EP3SE110	48,225,392	—	—	—	✓	✓
EP3SE260	93,324,656	—	—	—	✓ (2)	✓

Notes to Table 4-3:

- (1) These are uncompressed file sizes.
- (2) This is with the Stratix III compression feature enabled.

Table 4-4 lists the serial configuration device used with each Stratix II GX FPGA and the configuration file size. Stratix II GX devices can be used with EPCS16, EPCS64, or EPCS128.

Table 4-4. Serial Configuration Device Support for Stratix II GX Devices

Stratix II GX Device	Raw Binary File Size (Bits) (1)	Serial Configuration Device				
		EPCS1	EPCS4	EPCS16	EPCS64	EPCS128
EP2SGX30C EP2SGX30D	9,640,672	—	—	✓	✓	✓
EP2SGX60C EP2SGX60D EP2SGX60E	16,951,824	—	—	✓ (2)	✓	✓
EP2SGX90E EP2SGX90F	25,699,104	—	—	—	✓	✓
EP2SGX130G	37,325,760	—	—	—	✓	✓

Notes to Table 4-4:

- (1) These are uncompressed file sizes.
- (2) This is with the Stratix II GX compression feature enabled.

Table 4-5 lists the serial configuration device used with each Stratix II FPGA and the configuration file size. Stratix II devices can be used with EPCS4, EPCS16, EPCS64, or EPCS128.

Table 4-5. Serial Configuration Device Support for Stratix II Devices

Stratix II Device	Raw Binary File Size (Bits) (1)	Serial Configuration Device			
		EPCS4	EPCS16	EPCS64	EPCS128
EP2S15	4,721,544	✓ (2)	✓	✓	✓
EP2S30	9,640,672	—	✓	✓	✓
EP2S60	16,951,824	—	✓ (2)	✓	✓
EP2S90	25,699,104	—	✓ (2)	✓	✓
EP2S130	37,325,760	—	—	✓	✓
EP2S180	49,814,760	—	—	✓	✓

Notes to Table 4-5:

- (1) These are uncompressed file sizes.
- (2) This is with the Stratix II compression feature enabled.

Table 4-6 lists the serial configuration device used with each Arria GX FPGA and the configuration file size. Arria GX devices can be used with EPCS16, EPCS64, or EPCS128.

Table 4-6. Serial Configuration Device Support for Arria GX Devices

Arria GX Device	Raw Binary File Size (Bits) (1)	Serial Configuration Device				
		EPCS1	EPCS4	EPCS16	EPCS64	EPCS128
EP1AGX20C	9,640,672	—	—	✓	✓	✓
EP1AGX35C EP1AGX35D	9,640,672	—	—	✓	✓	✓
EP1AGX50C EP1AGX50D	16,951,824	—	—	✓ (2)	✓	✓
EP1AGX60C EP1AGX60D EP1AGX60E	16,951,824	—	—	✓ (2)	✓	✓
EP1AGX90E	25,699,104	—	—	—	✓	✓

Notes to Table 4-6:

- (1) These are uncompressed file sizes.
- (2) This is with the Arria GX compression feature enabled.

Table 4-7 lists the serial configuration device used with each Cyclone III FPGA and the configuration file size. Cyclone III devices can be used with EPCS4, EPCS16, EPCS64, or EPCS128.

Table 4-7. Serial Configuration Device for Cyclone III Devices

Cyclone III Device	Raw Binary File Size (Bits) (1)	Serial Configuration Device				
		EPCS1	EPCS4	EPCS16	EPCS64	EPCS128
EP3C5	2,944,088	—	✓	✓	✓	✓
EP3C10	2,944,088	—	✓	✓	✓	✓
EP3C16	4,086,848	—	✓	✓	✓	✓
EP3C25	5,748,552	—	✓ (2)	✓	✓	✓
EP3C40	9,534,304	—	—	✓	✓	✓
EP3C55	14,889,560	—	—	✓	✓	✓
EP3C80	19,965,752	—	—	✓ (2)	✓	✓
EP3C120	28,571,696	—	—	—	✓	✓

Notes to Table 4-7:

- (1) These are uncompressed file sizes.
- (2) This is with the Cyclone III compression feature enabled.

Table 4-8 lists the serial configuration device used with each Cyclone II FPGA and the configuration file size. Cyclone II devices can be used with EPCS1, EPCS4, EPCS16, EPCS64, or EPCS128.

Table 4-8. Serial Configuration Device for Cyclone II Devices

Cyclone II Device	Raw Binary File Size (Bits) (1)	Serial Configuration Device				
		EPCS1	EPCS4	EPCS16	EPCS64	EPCS128
EP2C5	1,265,792	✓ (2)	✓	✓	✓	✓
EP2C8	1,983,536	—	✓	✓	✓	✓
EP2C20	3,892,496	—	✓	✓	✓	✓
EP2C35	6,848,608	—	—	✓	✓	✓
EP2C50	9,951,104	—	—	✓	✓	✓
EP2C70	14,319,216	—	—	✓	✓	✓

Notes to Table 4-8:

- (1) These are uncompressed file sizes.
- (2) This is with the Cyclone II compression feature enabled.

Table 4-9 lists the serial configuration device used with each Cyclone FPGA and the configuration file size. Cyclone devices can be used with EPCS1, EPCS4, EPCS16, EPCS64, or EPCS128.

Table 4-9. Serial Configuration Device Support for Cyclone Devices

Cyclone Device	Raw Binary File Size (Bits) (1)	Serial Configuration Device				
		EPCS1	EPCS4	EPCS16	EPCS64	EPCS128
EP1C3	627,376	✓	✓	✓	✓	✓
EP1C4	924,512	✓	✓	✓	✓	✓
EP1C6	1,167,216	✓ (2)	✓	✓	✓	✓
EP1C12	2,323,240	—	✓	✓	✓	✓
EP1C20	3,559,608	—	✓	✓	✓	✓

Notes to Table 4-9:

- (1) These are uncompressed file sizes.
- (2) This is with the Cyclone compression feature enabled.

With the new data-decompression feature in the Stratix III, Stratix II GX, and Stratix II FPGAs, Arria GX FPGAs, and Cyclone FPGA families, you can use smaller serial configuration devices to configure larger FPGAs.



Serial configuration devices cannot be cascaded.



For more information about the FPGA decompression feature, refer to the configuration chapter in the appropriate device handbook.

The serial configuration devices are designed to configure Stratix III, Stratix II GX, and Stratix II FPGAs and the Cyclone series FPGAs and cannot configure other existing Altera FPGA device families.

Figure 4-1 shows the serial configuration device block diagram.

Figure 4-1. Serial Configuration Device Block Diagram

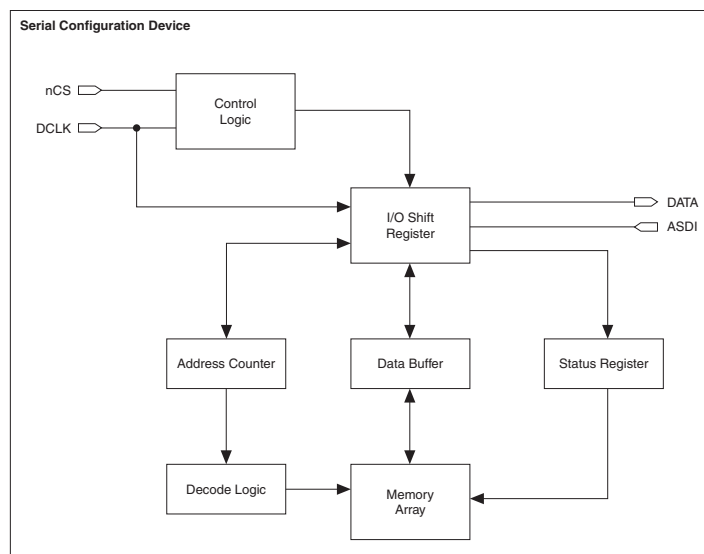

Accessing Memory in Serial Configuration Devices

You can access the unused memory locations of the serial configuration device to store or retrieve data through the Nios processor and SOPC Builder. SOPC Builder is an Altera tool for creating bus-based (especially microprocessor-based) systems in Altera devices. SOPC Builder assembles library components such as processors and memories into custom microprocessor systems.

SOPC Builder includes the EPCS device controller core, which is an interface core specifically designed to work with the serial configuration device. With this core, you can create a system with a Nios embedded processor that allows software access to any memory location within the serial configuration device.



For more information about accessing memory within the serial configuration device, refer to the [Active Serial Memory Interface Data Sheet](#).

Active Serial FPGA Configuration

The following Altera FPGAs support Active Serial (AS) configuration scheme with serial configuration devices:

- Stratix IV
- Stratix III
- Stratix II GX
- Stratix II
- Arria GX
- Cyclone series FPGAs



This section is only relevant for FPGAs that support the AS configuration scheme.

There are four signals on the serial configuration device that interface directly with the FPGA's control signals. The serial configuration device signals DATA, DCLK, ASDI, and nCS interface with DATA0, DCLK, ASDO, and nCSO control signals on the FPGA, respectively. [Figure 4-2](#) shows a serial configuration device programmed via a download cable, which configures an FPGA in AS mode. [Figure 4-3](#) shows a serial configuration device programmed using the APU or a third-party programmer configuring an FPGA in AS configuration mode.

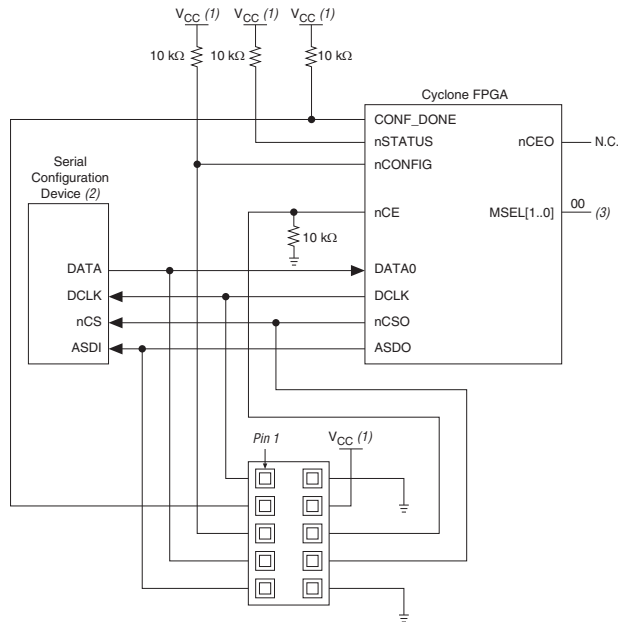

For more information about the serial configuration device pin description, refer to [Table 4-32](#).

Figure 4-2. Cyclone FPGA Configuration in AS Mode (Serial Configuration Device Programmed Using Download Cable)
(Note 4)**Notes to Figure 4-2:**

- (1) $V_{CC} = 3.3$ V.
- (2) Serial configuration devices cannot be cascaded.
- (3) Connect the FPGA $MSEL[]$ input pins to select the AS configuration mode. For details, refer to the appropriate FPGA family chapter in the *Configuration Handbook*.
- (4) For more information about configuration pin I/O requirements in an AS scheme for a Cyclone III FPGA, refer to the *Configuring Cyclone III Devices* chapter in volume 1 of the *Cyclone III Device Handbook*.

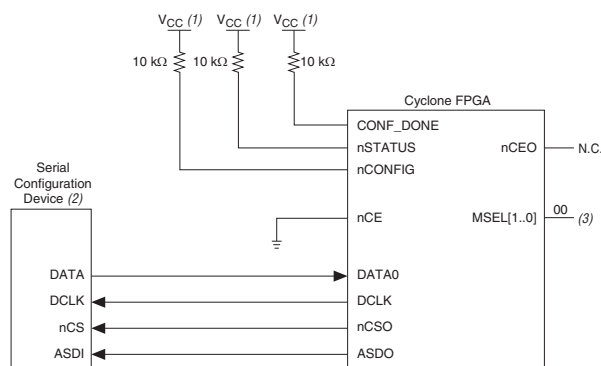
Figure 4-3. Cyclone FPGA Configuration in AS Mode (Serial Configuration Device Programmed by APU or Third-Party Programmer) (Note 4)**Notes to Figure 4-3:**

- (1) $V_{CC} = 3.3$ V.
- (2) Serial configuration devices cannot be cascaded.
- (3) Connect the FPGA $MSEL[]$ input pins to select the AS configuration mode. For details, refer to the appropriate FPGA family chapter in the *Configuration Handbook*.
- (4) For more information about configuration pin I/O requirements in an AS scheme for a Cyclone III FPGA, refer to the *Configuration Cyclone III Devices* chapter in volume 1 of the *Cyclone III Device Handbook*.

The FPGA acts as the configuration master in the configuration flow and provides the clock to the serial configuration device. The FPGA enables the serial configuration device by pulling the nCS signal low via the nCS0 signal (refer to [Figure 4-2](#) and [Figure 4-3](#)). Subsequently, the FPGA sends the instructions and addresses to the serial configuration device via the ASDO signal. The serial configuration device responds to the instructions by sending the configuration data to the FPGA's DATA0 pin on the falling edge of DCLK. The data is latched into the FPGA on the next DCLK signal's falling edge.

 Before the FPGA enters configuration mode, ensure that V_{CC} of the EPCS is ready. If it is not, you need to hold nCONFIG low until all power rails of EPCS are ready.

The FPGA controls the nSTATUS and CONF_DONE pins during configuration in AS mode. If the CONF_DONE signal does not go high at the end of configuration or if the signal goes high too early, the FPGA will pulse its nSTATUS pin low to start reconfiguration. Upon successful configuration, the FPGA releases the CONF_DONE pin, allowing the external 10-k Ω resistor to pull this signal high. Initialization begins after the CONF_DONE goes high. After initialization, the FPGA enters user mode.

 Refer to the configuration chapter in the appropriate device handbook for more information about configuring the FPGAs in AS mode or other configuration modes.

Multiple devices can be configured by a single EPCS device. However, serial configuration devices cannot be cascaded. Refer to [Table 4-1](#) to ensure the programming file size of the cascaded FPGAs does not exceed the capacity of a serial configuration device. [Figure 4-4](#) shows the AS configuration scheme with multiple FPGAs in the chain. The first FPGA is the configuration master and has its MSEL [] pins set to AS mode. The following FPGAs are configuration slave devices and have their MSEL [] pins set to PS mode.

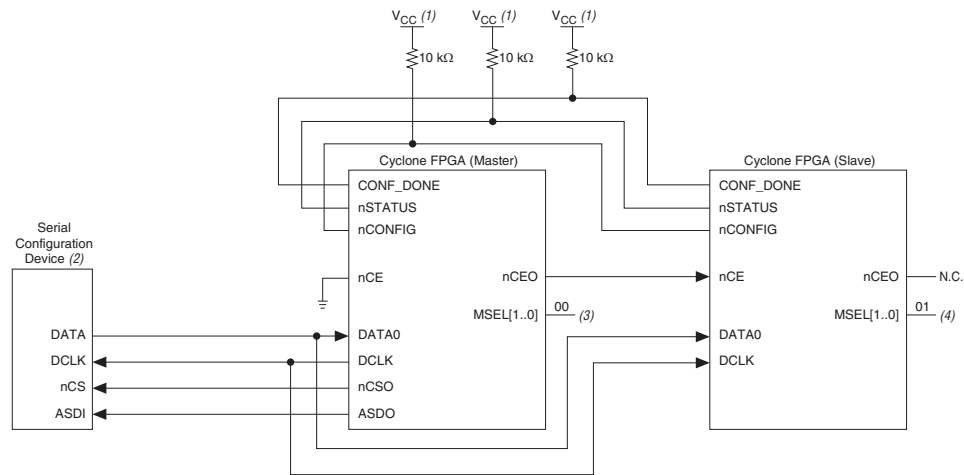
Figure 4-4. Multiple Devices in AS Mode (Note 1)**Notes to Figure 4-4:**

- (1) $V_{CC} = 3.3$ V.
- (2) Serial configuration devices cannot be cascaded.
- (3) Connect the FPGA MSEL [] input pins to select the AS configuration mode. For details, refer to the appropriate FPGA family chapter in the *Configuration Handbook*.
- (4) Connect the FPGA MSEL [] input pins to select the PS configuration mode. For details, refer to the appropriate FPGA family chapter in the *Configuration Handbook*.
- (5) For more information about configuration pin I/O requirements in an AS scheme for a Cyclone III FPGA, refer to the *Configuring Cyclone III Devices* chapter in volume 1 of the *Cyclone III Device Handbook*.

Serial Configuration Device Memory Access

This section describes the serial configuration device's memory array organization and operation codes. Timing specifications for the memory are provided in the "Timing Information" section.

Memory Array Organization

Table 4-10 provides details about the memory array organization in EPCS128, EPCS64, EPCS16, EPCS4, and EPCS1.

Table 4-10. Memory Array Organization in Serial Configuration Devices

Details	EPCS128	EPCS64	EPCS16	EPCS4	EPCS1
Bytes (bits)	16,777,216 bytes (128 Mbits)	8,388,608 bytes (64 Mbits)	2,097,152 bytes (16 Mbits)	524,288 bytes (4 Mbits)	131,072 bytes (1 Mbit)
Number of sectors	64	128	32	8	4
Bytes (bits) per sector	262,144 bytes (2 Mbits)	65,536 bytes (512 Kbits)	65,536 bytes (512 Kbits)	65,536 bytes (512 Kbits)	32,768 bytes (256 Kbits)
Pages per sector	1,024	256	256	256	128
Total number of pages	65,536	32,768	8,192	2,048	512
Bytes per page	256 bytes	256 bytes	256 bytes	256 bytes	256 bytes

Table 4-11 through Table 4-15 show the address range for each sector in EPCS128, EPCS64, EPCS16, EPCS4, and EPCS1.

Table 4-11. Address Range for Sectors in EPCS128 (Part 1 of 2)

Sector	Address Range (Byte Addresses in HEX)	
	Start	End
63	H'FC0000	H'FFFFFF
62	H'F80000	H'FBFFFF
61	H'F40000	H'F7FFFF
60	H'F00000	H'F3FFFF
59	H'EC0000	H'EFFFFFF
58	H'E80000	H'EBFFFF
57	H'E40000	H'E7FFFF
56	H'E00000	H'E3FFFF
55	H'DC0000	H'DFFFFFF
54	H'D80000	H'DBFFFF
53	H'D40000	H'D7FFFF
52	H'D00000	H'D3FFFF
51	H'CC0000	H'CFFFFFF
50	H'C80000	H'CBFFFF
49	H'C40000	H'C7FFFF
48	H'C00000	H'C3FFFF
47	H'BC0000	H'BFFFFFF
46	H'B80000	H'BBFFFF
45	H'B40000	H'B7FFFF
44	H'B00000	H'B3FFFF
43	H'AC0000	H'AFFFFFF
42	H'A80000	H'ABFFFF
41	H'A40000	H'A7FFFF
40	H'A00000	H'A3FFFF
39	H'9C0000	H'9FFFFFF
38	H'980000	H'9BFFFF
37	H'940000	H'97FFFF
36	H'900000	H'93FFFF
35	H'8C0000	H'8FFFFFF
34	H'880000	H'8BFFFF
33	H'840000	H'87FFFF
32	H'800000	H'83FFFF
31	H'7C0000	H'7FFFFFF
30	H'780000	H'7BFFFF
29	H'740000	H'77FFFF
28	H'700000	H'73FFFF

Table 4-11. Address Range for Sectors in EPCS128 (Part 2 of 2)

Sector	Address Range (Byte Addresses in HEX)	
	Start	End
27	H'6C0000	H'6FFFFFF
26	H'680000	H'6BFFFFFF
25	H'640000	H'67FFFFFF
24	H'600000	H'63FFFFFF
23	H'5C0000	H'5FFFFFF
22	H'580000	H'5BFFFFFF
21	H'540000	H'57FFFFFF
20	H'500000	H'53FFFFFF
19	H'4C0000	H'4FFFFFF
18	H'480000	H'4BFFFFFF
17	H'440000	H'47FFFFFF
16	H'400000	H'43FFFFFF
15	H'3C0000	H'3FFFFFF
14	H'380000	H'3BFFFFFF
13	H'340000	H'37FFFFFF
12	H'300000	H'33FFFFFF
11	H'2C0000	H'2FFFFFF
10	H'280000	H'2BFFFFFF
9	H'240000	H'27FFFFFF
8	H'200000	H'23FFFFFF
7	H'1C0000	H'1FFFFFF
6	H'180000	H'1BFFFFFF
5	H'140000	H'17FFFFFF
4	H'100000	H'13FFFFFF
3	H'0C0000	H'0FFFFFF
2	H'080000	H'0BFFFFFF
1	H'040000	H'07FFFFFF
0	H'000000	H'03FFFFFF

Table 4-12. Address Range for Sectors in EPCS64 (Part 1 of 5)

Sector	Address Range (Byte Addresses in HEX)	
	Start	End
127	H'7F0000	H'7FFFFFF
126	H'7E0000	H'7EFFFFFF
125	H'7D0000	H'7DFFFFFF
124	H'7C0000	H'7CFFFFFF
123	H'7B0000	H'7BFFFFFF
122	H'7A0000	H'7AFFFFFF

Table 4-12. Address Range for Sectors in EPCS64 (Part 2 of 5)

Sector	Address Range (Byte Addresses in HEX)	
	Start	End
121	H'790000	H'79FFFF
120	H'780000	H'78FFFF
119	H'770000	H'77FFFF
118	H'760000	H'76FFFF
117	H'750000	H'75FFFF
116	H'740000	H'74FFFF
115	H'730000	H'73FFFF
114	H'720000	H'72FFFF
113	H'710000	H'71FFFF
112	H'700000	H'70FFFF
111	H'6F0000	H'6FFFFF
110	H'6E0000	H'6EFFFF
109	H'6D0000	H'6DFFFF
108	H'6C0000	H'6CFFFF
107	H'6B0000	H'6BFFFF
106	H'6A0000	H'6AFFFF
105	H'690000	H'69FFFF
104	H'680000	H'68FFFF
103	H'670000	H'67FFFF
102	H'660000	H'66FFFF
101	H'650000	H'65FFFF
100	H'640000	H'64FFFF
99	H'630000	H'63FFFF
98	H'620000	H'62FFFF
97	H'610000	H'61FFFF
96	H'600000	H'60FFFF
95	H'5F0000	H'5FFFFF
94	H'5E0000	H'5EFFFF
93	H'5D0000	H'5DFFFF
92	H'5C0000	H'5CFFFF
91	H'5B0000	H'5BFFFF
90	H'5A0000	H'5AFFFF
89	H'590000	H'59FFFF
88	H'580000	H'58FFFF
87	H'570000	H'57FFFF
86	H'560000	H'56FFFF
85	H'550000	H'55FFFF
84	H'540000	H'54FFFF

Table 4-12. Address Range for Sectors in EPCS64 (Part 3 of 5)

Sector	Address Range (Byte Addresses in HEX)	
	Start	End
83	H'530000	H'53FFFF
82	H'520000	H'52FFFF
81	H'510000	H'51FFFF
80	H'500000	H'50FFFF
79	H'4F0000	H'4FFFFF
78	H'4E0000	H'4EFFFF
77	H'4D0000	H'4DFFFF
76	H'4C0000	H'4CFFFF
75	H'4B0000	H'4BFFFF
74	H'4A0000	H'4AFFFF
73	H'490000	H'49FFFF
72	H'480000	H'48FFFF
71	H'470000	H'47FFFF
70	H'460000	H'46FFFF
69	H'450000	H'45FFFF
68	H'440000	H'44FFFF
67	H'430000	H'43FFFF
66	H'420000	H'42FFFF
65	H'410000	H'41FFFF
64	H'400000	H'40FFFF
63	H'3F0000	H'3FFFFF
62	H'3E0000	H'3EFFFF
61	H'3D0000	H'3DFFFF
60	H'3C0000	H'3CFFFF
59	H'3B0000	H'3BFFFF
58	H'3A0000	H'3AFFFF
57	H'390000	H'39FFFF
56	H'380000	H'38FFFF
55	H'370000	H'37FFFF
54	H'360000	H'36FFFF
53	H'350000	H'35FFFF
52	H'340000	H'34FFFF
51	H'330000	H'33FFFF
50	H'320000	H'32FFFF
49	H'310000	H'31FFFF
48	H'300000	H'30FFFF
47	H'2F0000	H'2FFFFF
46	H'2E0000	H'2EFFFF

Table 4-12. Address Range for Sectors in EPCS64 (Part 4 of 5)

Sector	Address Range (Byte Addresses in HEX)	
	Start	End
45	H'2D0000	H'2DFFFF
44	H'2C0000	H'2CFFFF
43	H'2B0000	H'2BFFFF
42	H'2A0000	H'2AFFFF
41	H'290000	H'29FFFF
40	H'280000	H'28FFFF
39	H'270000	H'27FFFF
38	H'260000	H'26FFFF
37	H'250000	H'25FFFF
36	H'240000	H'24FFFF
35	H'230000	H'23FFFF
34	H'220000	H'22FFFF
33	H'210000	H'21FFFF
32	H'200000	H'20FFFF
31	H'1F0000	H'1FFFFF
30	H'1E0000	H'1EFFFF
29	H'1D0000	H'1DFFFF
28	H'1C0000	H'1CFFFF
27	H'1B0000	H'1BFFFF
26	H'1A0000	H'1AFFFF
25	H'190000	H'19FFFF
24	H'180000	H'18FFFF
23	H'170000	H'17FFFF
22	H'160000	H'16FFFF
21	H'150000	H'15FFFF
20	H'140000	H'14FFFF
19	H'130000	H'13FFFF
18	H'120000	H'12FFFF
17	H'110000	H'11FFFF
16	H'100000	H'10FFFF
15	H'0F0000	H'0FFFFF
14	H'0E0000	H'0EFFFF
13	H'0D0000	H'0DFFFF
12	H'0C0000	H'0CFFFF
11	H'0B0000	H'0BFFFF
10	H'0A0000	H'0AFFFF
9	H'090000	H'09FFFF
8	H'080000	H'08FFFF

Table 4-12. Address Range for Sectors in EPCS64 (Part 5 of 5)

Sector	Address Range (Byte Addresses in HEX)	
	Start	End
7	H'070000	H'07FFFF
6	H'060000	H'06FFFF
5	H'050000	H'05FFFF
4	H'040000	H'04FFFF
3	H'030000	H'03FFFF
2	H'020000	H'02FFFF
1	H'010000	H'01FFFF
0	H'000000	H'00FFFF

Table 4-13. Address Range for Sectors in EPCS16 (Part 1 of 2)

Sector	Address Range (Byte Addresses in HEX)	
	Start	End
31	H'1F0000	H'1FFFFFFF
30	H'1E0000	H'1EFFFFFF
29	H'1D0000	H'1DFFFFFF
28	H'1C0000	H'1CFFFFFF
27	H'1B0000	H'1BFFFFFF
26	H'1A0000	H'1AFFFFFF
25	H'190000	H'19FFFFFF
24	H'180000	H'18FFFFFF
23	H'170000	H'17FFFFFF
22	H'160000	H'16FFFFFF
21	H'150000	H'15FFFFFF
20	H'140000	H'14FFFFFF
19	H'130000	H'13FFFFFF
18	H'120000	H'12FFFFFF
17	H'110000	H'11FFFFFF
16	H'100000	H'10FFFFFF
15	H'0F0000	H'0FFFFFFF
14	H'0E0000	H'0EFFFFFF
13	H'0D0000	H'0DFFFFFF
12	H'0C0000	H'0CFFFFFF
11	H'0B0000	H'0BFFFFFF
10	H'0A0000	H'0AFFFFFF
9	H'090000	H'09FFFFFF
8	H'080000	H'08FFFFFF
7	H'070000	H'07FFFFFF
6	H'060000	H'06FFFFFF

Table 4-13. Address Range for Sectors in EPCS16 (Part 2 of 2)

Sector	Address Range (Byte Addresses in HEX)	
	Start	End
5	H'050000	H'05FFFF
4	H'040000	H'04FFFF
3	H'030000	H'03FFFF
2	H'020000	H'02FFFF
1	H'010000	H'01FFFF
0	H'000000	H'00FFFF

Table 4-14. Address Range for Sectors in EPCS4

Sector	Address Range (Byte Addresses in HEX)	
	Start	End
7	H'70000	H'7FFFF
6	H'60000	H'6FFFF
5	H'50000	H'5FFFF
4	H'40000	H'4FFFF
3	H'30000	H'3FFFF
2	H'20000	H'2FFFF
1	H'10000	H'1FFFF
0	H'00000	H'0FFFF

Table 4-15. Address Range for Sectors in EPCS1

Sector	Address Range (Byte Addresses in HEX)	
	Start	End
3	H'18000	H'1FFFF
2	H'10000	H'17FFF
1	H'08000	H'0FFFF
0	H'00000	H'07FFF

Operation Codes

This section describes the operations that can be used to access the memory in serial configuration devices. The DATA, DCLK, ASDI, and nCS signals access the memory in serial configuration devices. All serial configuration device operation codes, addresses and data are shifted in and out of the device serially, with the most significant bit (MSB) first.

The device samples the active serial data input on the first rising edge of the DCLK after the active low chip select (nCS) input signal is driven low. Shift the operation code (MSB first) serially into the serial configuration device through the active serial data input (ASDI) pin. Each operation code bit is latched into the serial configuration device on the rising edge of the DCLK.

Different operations require a different sequence of inputs. While executing an operation, you must shift in the desired operation code, followed by the address bytes, data bytes, both, or neither. The device must drive \overline{nCS} high after the last bit of the operation sequence is shifted in. Table 4-16 shows the operation sequence for every operation supported by the serial configuration devices.

For the read byte, read status, and read silicon ID operations, the shifted-in operation sequence is followed by data shifted out on the \overline{DATA} pin. You can drive the \overline{nCS} pin high after any bit of the data-out sequence is shifted out.

For the write byte, erase bulk, erase sector, write enable, write disable, and write status operations, drive the \overline{nCS} pin high exactly at a byte boundary (drive the \overline{nCS} pin high a multiple of eight clock pulses after the \overline{nCS} pin is driven low); otherwise, the operation is rejected and is not executed.

All attempts to access the memory contents while a write or erase cycle is in progress will not be granted, and the write or erase cycle will continue unaffected.

Table 4-16. Operation Codes for Serial Configuration Devices

Operation	Operation Code (1)	Address Bytes	Dummy Bytes	Data Bytes	DCLK f_{MAX} (MHz)
Write enable	0000 0110	0	0	0	25
Write disable	0000 0100	0	0	0	25
Read status	0000 0101	0	0	1 to infinite (2)	25
Read bytes	0000 0011	3	0	1 to infinite (2)	20
Read silicon ID (4)	1010 1011	0	3	1 to infinite (2)	25
Write status	0000 0001	0	0	1	25
Write bytes	0000 0010	3	0	1 to 256 (3)	25
Erase bulk	1100 0111	0	0	0	25
Erase sector	1101 1000	3	0	0	25
Read Device Identification (5)	1001 1111	0	2	1 to infinite (2)	25

Notes to Table 4-16:

- (1) The MSB is listed first and the least significant bit (LSB) is listed last.
- (2) The status register, data or silicon ID are read out at least once on the \overline{DATA} pin and will continuously be read out until \overline{nCS} is driven high.
- (3) Write bytes operation requires at least one data byte on the \overline{DATA} pin. If more than 256 bytes are sent to the device, only the last 256 bytes are written to the memory.
- (4) Read silicon ID operation is available only for EPCS1, EPCS4, EPCS16, and EPCS64.
- (5) Read Device Identification operation is available only for EPCS128.

Write Enable Operation

The write enable operation code is b'0000 0110, and the MSB is listed first. The write enable operation sets the write enable latch bit, which is bit 1 in the status register. Always set the write enable latch bit before write bytes, write status, erase bulk, and erase sector operations. Figure 4-5 shows the timing diagram for the write enable operation. Figure 4-7 and Figure 4-8 show the status register bit definitions.

Figure 4-5. Write Enable Operation Timing Diagram

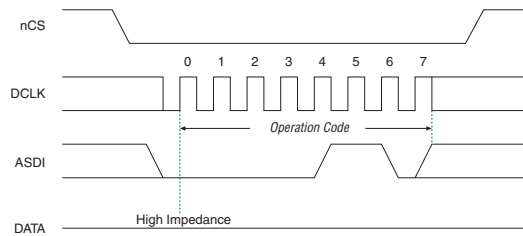

Write Disable Operation

The write disable operation code is b'0000 0100, with the MSB listed first. The write disable operation resets the write enable latch bit, which is bit 1 in the status register. To prevent the memory from being written unintentionally, the write enable latch bit is automatically reset when implementing the write disable operation as well as under the following conditions:

- Power up
- Write bytes operation completion
- Write status operation completion
- Erase bulk operation completion
- Erase sector operation completion

Figure 4-6 shows the timing diagram for the write disable operation.

Figure 4-6. Write Disable Operation Timing Diagram

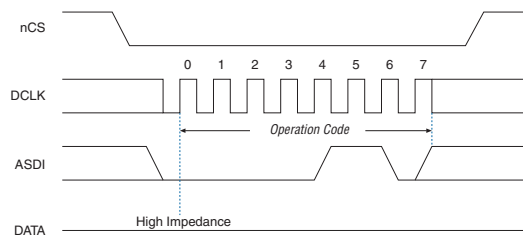

Read Status Operation

The read status operation code is $b'0000\ 0101$, with the MSB listed first. You can use the read status operation to read the status register. [Figure 4-7](#) and [Figure 4-8](#) show the status bits in the status register of the serial configuration devices.

Figure 4-7. EPCS4, EPCS16, EPCS64, and EPCS128 Status Register Status Bits

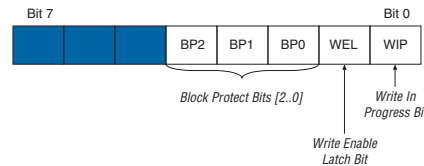
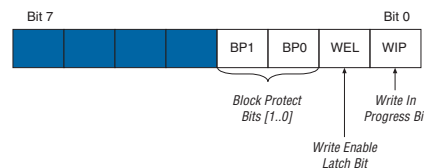

Figure 4-8. EPCS1 Status Register Status Bits



Setting the write in progress bit to 1 indicates that the serial configuration device is busy with a write or erase cycle. Resetting the write in progress bit to 0 means no write or erase cycle is in progress.

Resetting the write enable latch bit to 0 indicates that no write or erase cycle will be accepted. Set the write enable latch bit to 1 before every write bytes, write status, erase bulk, and erase sector operation.

The non-volatile block protect bits determine the area of the memory protected from being written or erased unintentionally. [Table 4-17](#) through [Table 4-21](#) show the protected area in the serial configuration devices with reference to the block protect bits. The erase bulk operation is only available when all the block protect bits are 0. When any of the block protect bits are set to 1, the relevant area is protected from being written by write bytes operations or erased by erase sector operations.

Table 4-17. Block Protection Bits in EPCS1

Status Register Content		Memory Content	
BP1 Bit	BP0 Bit	Protected Area	Unprotected Area
0	0	None	All four sectors: 0 to 3
0	1	Sector 3	Three sectors: 0 to 2
1	0	Two sectors: 2 and 3	Two sectors: 0 and 1
1	1	All sectors	None

Table 4-18. Block Protection Bits in EPCS4

Status Register Content			Memory Content	
BP2 Bit	BP1 Bit	BPO Bit	Protected Area	Unprotected Area
0	0	0	None	All eight sectors: 0 to 7
0	0	1	Sector 7	Seven sectors: 0 to 6
0	1	0	Sectors 6 and 7	Six sectors: 0 to 5
0	1	1	Four sectors: 4 to 7	Four sectors: 0 to 3
1	0	0	All sectors	None
1	0	1	All sectors	None
1	1	0	All sectors	None
1	1	1	All sectors	None

Table 4-19. Block Protection Bits in EPCS16

Status Register Content			Memory Content	
BP2 Bit	BP1 Bit	BPO Bit	Protected Area	Unprotected Area
0	0	0	None	All sectors (32 sectors 0 to 31)
0	0	1	Upper 32nd (Sector 31)	Lower 31/32nds (31 sectors: 0 to 30)
0	1	0	Upper sixteenth (two sectors: 30 and 31)	Lower 15/16ths (30 sectors: 0 to 29)
0	1	1	Upper eighth (four sectors: 28 to 31)	Lower seven-eighths (28 sectors: 0 to 27)
1	0	0	Upper quarter (eight sectors: 24 to 31)	Lower three-quarters (24 sectors: 0 to 23)
1	0	1	Upper half (sixteen sectors: 16 to 31)	Lower half (16 sectors: 0 to 15)
1	1	0	All sectors (32 sectors: 0 to 31)	None
1	1	1	All sectors (32 sectors: 0 to 31)	None

Table 4-20. Block Protection Bits in EPCS64

Status Register Content			Memory Content	
BP2 Bit	BP1 Bit	BPO Bit	Protected Area	Unprotected Area
0	0	0	None	All sectors (128 sectors: 0 to 127)
0	0	1	Upper 64th (2 sectors: 126 and 127)	Lower 63/64ths (126 sectors: 0 to 125)
0	1	0	Upper 32nd (4 sectors: 124 to 127)	Lower 31/32nds (124 sectors: 0 to 123)
0	1	1	Upper sixteenth (8 sectors: 120 to 127)	Lower 15/16ths (120 sectors: 0 to 119)
1	0	0	Upper eighth (16 sectors: 112 to 127)	Lower seven-eighths (112 sectors: 0 to 111)
1	0	1	Upper quarter (32 sectors: 96 to 127)	Lower three-quarters (96 sectors: 0 to 95)
1	1	0	Upper half (64 sectors: 64 to 127)	Lower half (64 sectors: 0 to 63)
1	1	1	All sectors (128 sectors: 0 to 127)	None

Table 4-21. Block Protection Bits in EPCS128

Status Register Content			Memory Content	
BP2 Bit	BP1 Bit	BPO Bit	Protected Area	Unprotected Area
0	0	0	None	All sectors (64 sectors: 0 to 63)
0	0	1	Upper 64th (1 sector: 63)	Lower 63/64ths (63 sectors: 0 to 62)
0	1	0	Upper 32nd (2 sectors: 62 to 63)	Lower 31/32nds (62 sectors: 0 to 61)
0	1	1	Upper 16th (4 sectors: 60 to 63)	Lower 15/16ths (60 sectors: 0 to 59)
1	0	0	Upper 8th (8 sectors: 56 to 63)	Lower seven-eighths (56 sectors: 0 to 55)
1	0	1	Upper quarter (16 sectors: 48 to 63)	Lower three-quarters (48 sectors: 0 to 47)
1	1	0	Upper half (32 sectors: 32 to 63)	Lower half (32 sectors: 0 to 31)
1	1	1	All sectors (64 sectors: 0 to 63)	None

You can read the status register at any time, even while a write or erase cycle is in progress. When one of these cycles is in progress, you can check the write in progress bit (bit 0 of the status register) before sending a new operation to the device. The device can also read the status register continuously, as shown in [Figure 4-9](#).

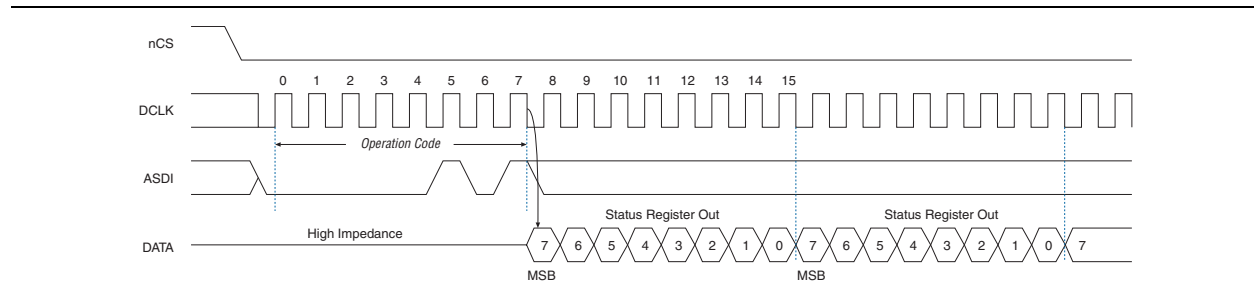
Figure 4-9. Read Status Operation Timing Diagram

Write Status Operation

The write status operation code is $b'0000\ 0001$, with the MSB listed first. Use the write status operation to set the status register block protection bits. The write status operation has no effect on the other bits. Therefore, you can implement this operation to protect certain memory sectors, as defined in [Table 4-17](#) through [Table 4-21](#). After setting the block protect bits, the protected memory sectors are treated as read-only memory. You must execute the write enable operation before the write status operation so the device sets the status register's write enable latch bit to 1.

The write status operation is implemented by driving nCS low, followed by shifting in the write status operation code and one data byte for the status register on the ASDI pin. [Figure 4-10](#) shows the timing diagram for the write status operation. nCS must be driven high after the eighth bit of the data byte has been latched in, otherwise, the write status operation is not executed.

Immediately after nCS drives high, the device initiates the self-timed write status cycle. The self-timed write status cycle usually takes 5 ms for all serial configuration devices and is guaranteed to be less than 15 ms (refer to t_{WS} in Table 4-24). You must account for this delay to ensure that the status register is written with desired block protect bits. Alternatively, you can check the write in progress bit in the status register by executing the read status operation while the self-timed write status cycle is in progress. The write in progress bit is 1 during the self-timed write status cycle, and 0 when it is complete.

Figure 4-10. Write Status Operation Timing Diagram

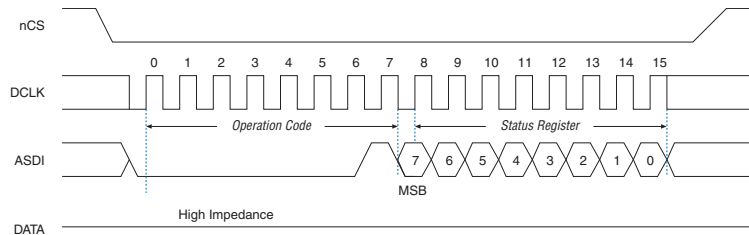

Read Bytes Operation

The read bytes operation code is $b'0000\ 0011$, with the MSB listed first. To read the memory contents of the serial configuration device, the device is first selected by driving nCS low. Then, the read bytes operation code is shifted in followed by a 3-byte address ($A[23..0]$). Each address bit must be latched in on the rising edge of the DCLK. After the address is latched in, the memory contents of the specified address are shifted out serially on the DATA pin, beginning with the MSB. For reading Raw Programming Data files (.rpd), the content is shifted out serially beginning with the LSB. Each data bit is shifted out on the falling edge of DCLK. The maximum DCLK frequency during the read bytes operation is 20 MHz. Figure 4-11 shows the timing diagram for the read bytes operation.

The first byte address can be at any location. The device automatically increments the address to the next higher address after shifting out each byte of data. Therefore, the device can read the whole memory with a single read bytes operation. When the device reaches the highest address, the address counter restarts at $0x000000$, allowing the memory contents to be read out indefinitely until the read bytes operation is terminated by driving nCS high. The device can drive nCS high any time after data is shifted out. If the read bytes operation is shifted in while a write or erase cycle is in progress, the operation is not executed and has no effect on the write or erase cycle in progress.

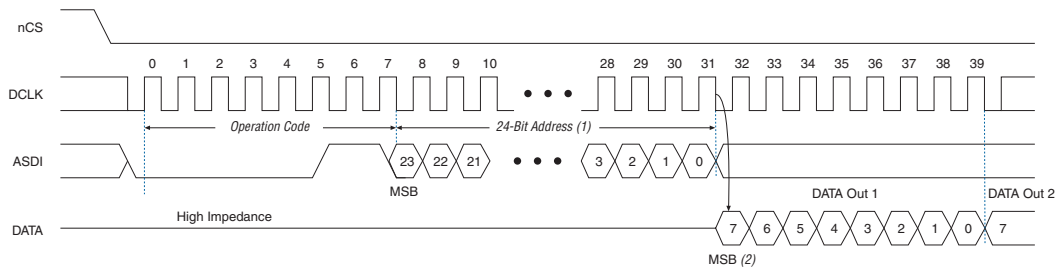
Figure 4-11. Read Bytes Operation Timing Diagram**Notes to Figure 4-11:**

- (1) Address bit $A[23]$ is a don't-care bit in EPCS64. Address bits $A[23..21]$ are don't-care bits in EPCS16. Address bits $A[23..19]$ are don't-care bits in EPCS4. Address bits $A[23..17]$ are don't-care bits in the EPCS1.
- (2) For RPD files, the read sequence shifts out the LSB of the data byte first.

Read Silicon ID Operation

The read silicon ID operation code is $b'1010\ 1011$, with the MSB listed first. Only EPCS1, EPCS4, EPCS16, and EPCS64 support this operation. It reads the serial configuration device's 8-bit silicon ID from the DATA output pin. If this operation is shifted in during an erase or write cycle, it is ignored and has no effect on the cycle that is in progress.

Table 4-22 shows the serial configuration device silicon IDs.

Table 4-22. Serial Configuration Device Silicon ID

Serial Configuration Device	Silicon ID (Binary Value)
EPCS1	$b'0001\ 0000$
EPCS4	$b'0001\ 0010$
EPCS16	$b'0001\ 0100$
EPCS64	$b'0001\ 0110$

The device implements the read silicon ID operation by driving nCS low then shifting in the read silicon ID operation code followed by three dummy bytes on ASDI. The serial configuration device's 8-bit silicon ID is then shifted out on the DATA pin on the falling edge of DCLK, as shown in Figure 4-12. The device can terminate the read silicon ID operation by driving nCS high after the silicon ID has been read at least once. Sending additional clock cycles on DCLK while nCS is driven low can cause the silicon ID to be shifted out repeatedly.

Figure 4-12. Read Silicon ID Operation Timing Diagram (Note 1)

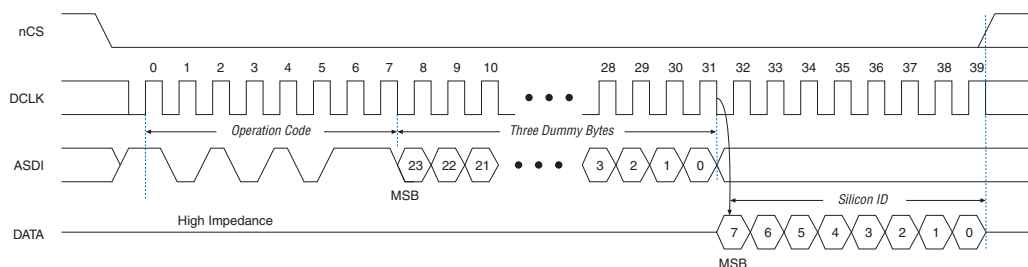

Note to Figure 4-12:

(1) Only EPCS1, EPCS4, EPCS16, and EPCS64 support Read Silicon ID operation.

Read Device Identification Operation

The read device identification operation code is $b'1001\ 1111$, with the MSB listed first. Only EPCS128 supports this operation. It reads the serial configuration device's 8-bit device identification from the DATA output pin. If this operation is shifted in during an erase or write cycle, it is ignored and has no effect on the cycle that is in progress. Table 4-23 shows the serial configuration device identification.

Table 4-23. Serial Configuration Device Identification

Serial Configuration Device	Silicon ID (Binary Value)
EPCS128	$b'0001\ 1000$

The device implements the read device identification operation by driving nCS low then shifting in the read device identification operation code followed by two dummy byte on ASDI. The serial configuration device's 16-bit device identification is then shifted out on the DATA pin on the falling edge of DCLK, as shown in Figure 4-13. The device can terminate the read device identification operation by driving nCS high after reading the device identification at least once.

Figure 4-13. Read Device Identification Operation Timing Diagram (Note 1)

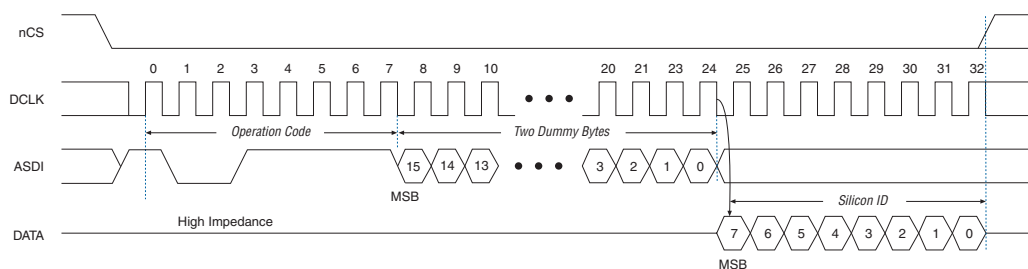

Note to Figure 4-13:

(1) Only EPCS128 supports read device identification operation.

Write Bytes Operation

The write bytes operation code is $b'0000\ 0010$, with the MSB listed first. The write bytes operation allows bytes to be written to the memory. The write enable operation must be executed prior to the write bytes operation to set the write enable latch bit in the status register to 1.

The write bytes operation is implemented by driving nCS low, followed by the write bytes operation code, three address bytes and a minimum one data byte on ASDI. If the eight least significant address bits ($A[7..0]$) are not all 0, all sent data that goes beyond the end of the current page is not written into the next page. Instead, this data is written at the start address of the same page (from the address whose eight LSBs are all 0). Drive nCS low during the entire write bytes operation sequence, as shown in Figure 4-14.

If more than 256 data bytes are shifted into the serial configuration device with a write bytes operation, the previously latched data is discarded and the last 256 bytes are written to the page. However, if less than 256 data bytes are shifted into the serial configuration device, they are guaranteed to be written at the specified addresses and the other bytes of the same page are unaffected.

If the design must write more than 256 data bytes to the memory, it needs more than one page of memory. Send the write enable and write bytes operation codes followed by three new targeted address bytes and 256 data bytes before a new page is written.

nCS must be driven high after the eighth bit of the last data byte has been latched in. Otherwise, the device will not execute the write bytes operation. The write enable latch bit in the status register is reset to 0 before the completion of each write bytes operation. Therefore, the write enable operation must be carried out before the next write bytes operation.

The device initiates the self-timed write cycle immediately after nCS is driven high. Refer to t_{WB} in Table 4-24 for the self-timed write cycle time for the respective EPCS devices. Therefore, you must account for this amount of delay before another page of memory is written. Alternatively, you can check the status register's write in progress bit by executing the read status operation while the self-timed write cycle is in progress. The write in progress bit is set to 1 during the self-timed write cycle, and 0 when it is complete.

Figure 4-14. Write Bytes Operation Timing Diagram

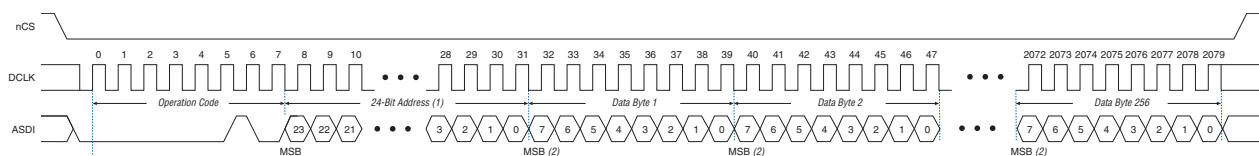

Notes to Figure 4-14:

- (1) Address bit $A[23]$ is a don't-care bit in EPCS64. Address bits $A[23..21]$ are don't-care bits in EPCS16. Address bits $A[23..19]$ are don't-care bits in EPCS4. Address bits $A[23..17]$ are don't-care bits in EPCS1.
- (2) For RPD files, write the LSB of the data byte first.

Erase Bulk Operation

The erase bulk operation code is $b'1100\ 0111$, with the MSB listed first. The erase bulk operation sets all memory bits to 1 or $0xFF$. Similar to the write bytes operation, the write enable operation must be executed prior to the erase bulk operation so that the write enable latch bit in the status register is set to 1.

You can implement the erase bulk operation by driving nCS low and then shifting in the erase bulk operation code on the ASDI pin. nCS must be driven high after the eighth bit of the erase bulk operation code has been latched in. Figure 4-15 shows the timing diagram.

The device initiates the self-timed erase bulk cycle immediately after nCS is driven high. Refer to t_{EB} in Table 4-24 for the self-timed erase bulk cycle time for the respective EPCS devices.

You must account for this delay before accessing the memory contents. Alternatively, you can check the write in progress bit in the status register by executing the read status operation while the self-timed erase cycle is in progress. The write in progress bit is 1 during the self-timed erase cycle and 0 when it is complete. The write enable latch bit in the status register is reset to 0 before the erase cycle is complete.

Figure 4-15. Erase Bulk Operation Timing Diagram

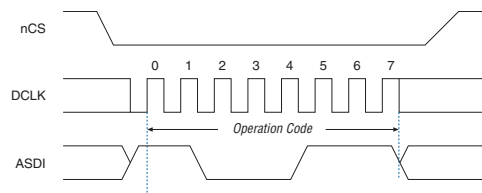

Erase Sector Operation

The erase sector operation code is $b'1101\ 1000$, with the MSB listed first. The erase sector operation allows the user to erase a certain sector in the serial configuration device by setting all bits inside the sector to 1 or $0xFF$. This operation is useful for users who access the unused sectors as general purpose memory in their applications.

The write enable operation must be executed prior to the erase sector operation so that the write enable latch bit in the status register is set to 1.

The erase sector operation is implemented by first driving nCS low, then shifting in the erase sector operation code and the three address bytes of the chosen sector on the ASDI pin. The three address bytes for the erase sector operation can be any address inside the specified sector. (Refer to Table 4-11 through Table 4-15 for sector address range information.) Drive nCS high after the eighth bit of the erase sector operation code has been latched in. Figure 4-16 shows the timing diagram.

Immediately after the device drives nCS high, the self-timed erase sector cycle is initiated. Refer to t_{ES} in Table 4-24 for the self-timed erase sector cycle time for the respective EPCS devices. You must account for this amount of delay before the memory contents can be accessed. Alternatively, you can check the write in progress bit in the status register by executing the read status operation while the erase cycle is in progress. The write in progress bit is 1 during the self-timed erase cycle and 0 when it is complete. The write enable latch bit in the status register resets to 0 before the erase cycle is complete.

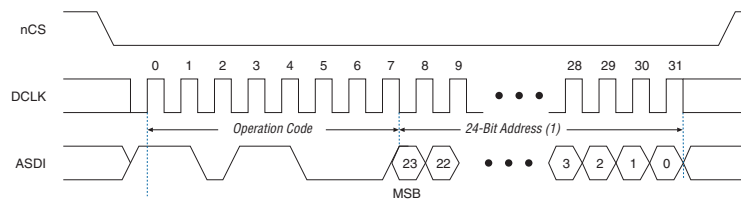
Figure 4-16. Erase Sector Operation Timing Diagram**Note to Figure 4-16:**

(1) Address bit A[23] is a don't-care bit in EPCS64. Address bits A[23..21] are don't-care bits in EPCS16. Address bits A[23..19] are don't-care bits in EPCS4. Address bits A[23..17] are don't-care bits in EPCS1.

Power and Operation

This section describes the power modes, power-on reset (POR) delay, error detection, and initial programming state of serial configuration devices.

Power Mode

Serial configuration devices support active power and standby power modes. When nCS is low, the device is enabled and is in active power mode. The FPGA is configured while in active power mode. When nCS is high, the device is disabled but could remain in active power mode until all internal cycles have completed (such as write or erase operations). The serial configuration device then goes into stand-by power mode. The I_{CC1} parameter specifies the V_{CC} supply current when the device is in active power mode and the I_{CC0} parameter specifies the current when the device is in stand-by power mode (refer to Table 4-30).

Power-On Reset

During initial power-up, a POR delay occurs to ensure the system voltage levels have stabilized. During AS configuration, the FPGA controls the configuration and has a longer POR delay than the serial configuration device.



For the POR delay time, refer to the configuration chapter in the appropriate device handbook.

Error Detection

During AS configuration with the serial configuration device, the FPGA monitors the configuration status through the nSTATUS and CONF_DONE pins. If an error condition occurs (nSTATUS drives low) or if the CONF_DONE pin does not go high, the FPGA will initiate reconfiguration by pulsing the nSTATUS and nCS0 signals, which controls the chip select pin on the serial configuration device (nCS).

After an error, configuration automatically restarts if the **Auto-Restart Upon Frame Error** option is turned on in the Quartus II software. If the option is turned off, the system must monitor the nSTATUS signal for errors and then pulse the nCONFIG signal low to restart configuration.

Timing Information

Figure 4-17 shows the timing waveform for write operation to the serial configuration device.

Figure 4-17. Write Operation Timing

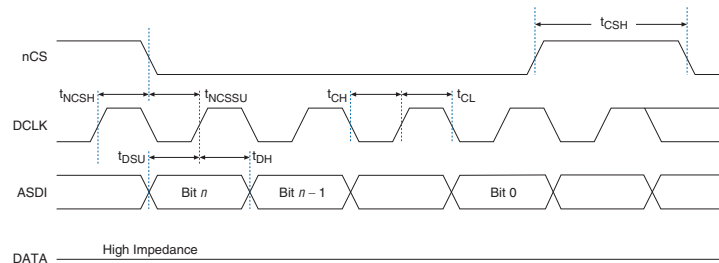

Table 4-24 defines the serial configuration device timing parameters for write operation.

Table 4-24. Write Operation Parameters

Symbol	Parameter	Min	Typ	Max	Unit
f_{WCLK}	Write clock frequency (from FPGA, download cable, or embedded processor) for write enable, write disable, read status, read silicon ID, write bytes, erase bulk, and erase sector operations	—	—	25	MHz
t_{CH}	DCLK high time	20	—	—	ns
t_{CL}	DCLK low time	20	—	—	ns
t_{NCSU}	Chip select (nCS) setup time	10	—	—	ns
t_{NCSH}	Chip select (nCS) hold time	10	—	—	ns
t_{DSU}	Data ($ASDI$) in setup time before rising edge on DCLK	5	—	—	ns
t_{DH}	Data ($ASDI$) hold time after rising edge on DCLK	5	—	—	ns
t_{CSH}	Chip select high time	100	—	—	ns
$t_{WB} (1)$	Write bytes cycle time for EPCS1, EPCS4, EPCS16, and EPCS64	—	1.5	5	ms
	Write bytes cycle time for EPCS128	—	2.5	7	ms
$t_{WS} (1)$	Write status cycle time	—	5	15	ms
$t_{EB} (1)$	Erase bulk cycle time for EPCS1	—	3	6	s
	Erase bulk cycle time for EPCS4	—	5	10	s
	Erase bulk cycle time for EPCS16	—	17	40	s
	Erase bulk cycle time for EPCS64	—	68	160	s
	Erase bulk cycle time for EPCS128	—	105	250	s
$t_{ES} (1)$	Erase sector cycle time for EPCS1, EPCS4, EPCS16, and EPCS64	—	2	3	s
	Erase sector cycle time for EPCS128	—	2	6	s

Note to Table 4-24:

(1) These parameters are not shown in Figure 4-17.

Figure 4–18 shows the timing waveform for the serial configuration device's read operation.

Figure 4–18. Read Operation Timing

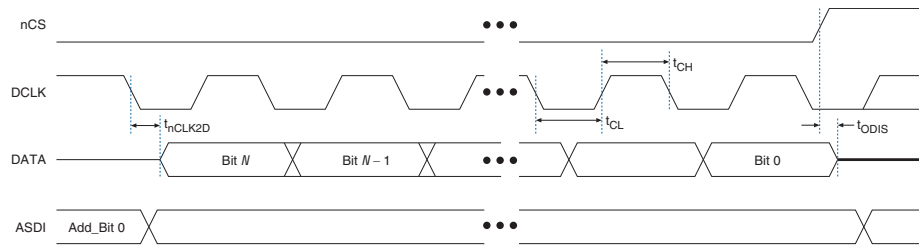

Table 4–25 defines the serial configuration device timing parameters for read operation.

Table 4–25. Read Operation Parameters

Symbol	Parameter	Min	Max	Unit
f_{RCLK}	Read clock frequency (from FPGA or embedded processor) for read bytes operation	—	20	MHz
t_{CH}	DCLK high time	25	—	ns
t_{CL}	DCLK low time	25	—	ns
t_{ODIS}	Output disable time after read	—	15	ns
t_{nCLK2D}	Clock falling edge to data	—	8	ns

Figure 4-19 shows the timing waveform for FPGA AS configuration scheme using a serial configuration device.

Figure 4-19. AS Configuration Timing

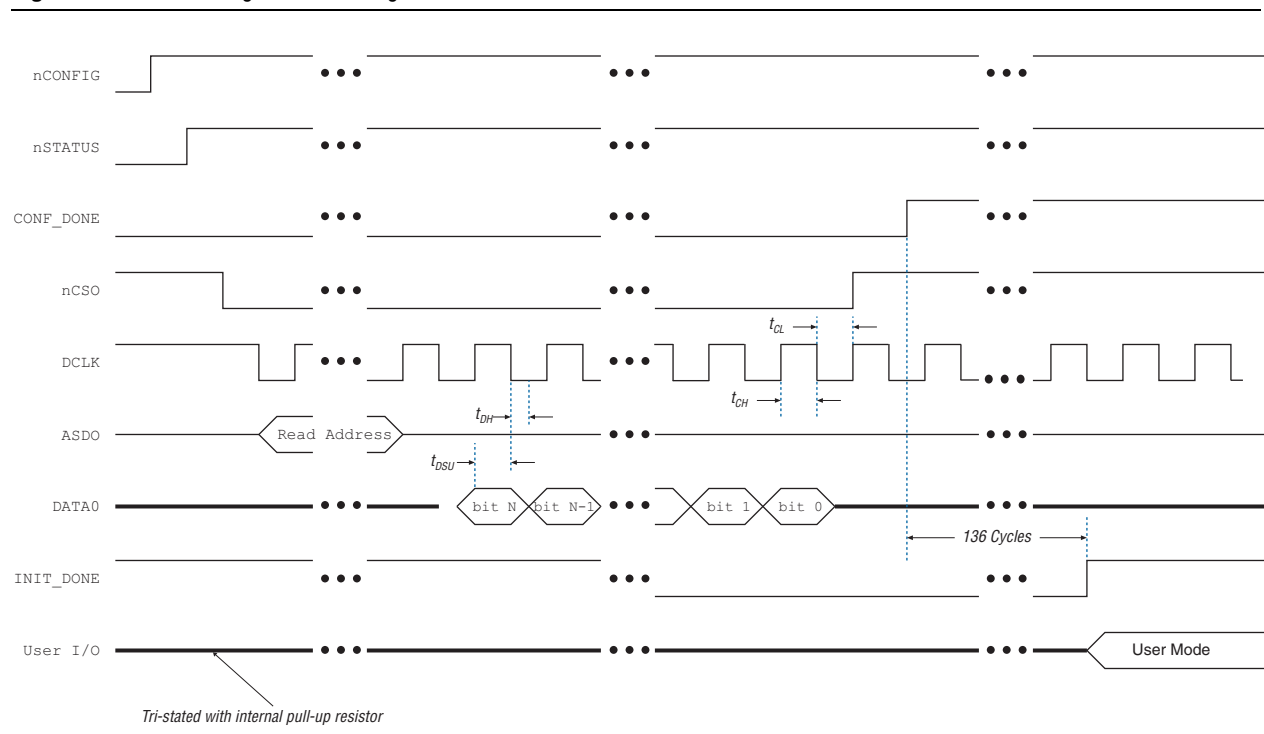

Table 4-26 shows the timing parameters for AS configuration mode.

Table 4-26. Timing Parameters for AS Configuration

Symbol	Parameter	Min	Typ	Max	Unit
f_{CLK}	DCLK frequency from Cyclone FPGA	14	17	20	MHz
	DCLK frequency from Stratix II or Cyclone II FPGA (40 MHz) (1)	20	26	40	MHz
	DCLK frequency from Stratix II or Cyclone II FPGA (20 MHz)	10	13	20	MHz
	DCLK frequency from Cyclone III FPGA (1)	20	30	40	MHz
	DCLK frequency from Stratix III FPGA (1)	15	25	40	MHz
	DCLK frequency from Arria GX FPGA (40 MHz) (1)	20	26	40	MHz
	DCLK frequency from Arria GX FPGA (40 MHz)	10	13	20	MHz
t_{DH}	Data hold time after falling edge on DCLK	0	—	—	ns
t_{DSU}	Data set up time before falling edge on DCLK	7	—	—	ns

Note to Table 4-26:

- (1) Existing batches of EPCS1 and EPCS4 manufactured on 0.15 μ m process geometry supports AS configuration up to 40 MHz. However, batches of EPCS1 and EPCS4 manufactured on 0.18 μ m process geometry support only up to 20 MHz. EPCS16, EPCS64, and EPCS128 are not affected. For information about product traceability and transition date to differentiate between 0.15 μ m process geometry and 0.18 μ m process geometry EPCS1 and EPCS4, refer to PCN 0514 Manufacturing Changes on EPCS Family process change notification on the Altera website at www.altera.com.

Programming and Configuration File Support

The Quartus II design software provides programming support for serial configuration devices. After selecting the serial configuration device, the Quartus II software automatically generates the Programmer Object File (.pof) to program the device. The software allows users to select the appropriate serial configuration device density that most efficiently stores the configuration data for a selected FPGA.

The serial configuration device can be programmed in-system by an external microprocessor using SRunner. SRunner is a software driver developed for embedded serial configuration device programming that designers can customize to fit in different embedded systems. The SRunner can read RPD file and write to the serial configuration devices. The programming time is comparable to the Quartus II software programming time. Note that writing and reading the RPD file to the EPCS is different from other data and address bytes. The LSB of RPD bytes must be shifted out first during the read bytes instruction and the LSB of RPD bytes must be shifted in first during the write bytes instruction. This is because the FPGA reads the LSB of the RPD data first during the configuration process.

 For more information about SRunner, refer to *AN 418: SRunner: An Embedded Solution for Serial Configuration Device Programming User Guide* and the source code on the Altera website (www.altera.com).

Serial configuration devices can be programmed using the APU with the appropriate programming adapter (PLMSEPC-8) via the Quartus II software, USB Blaster, EthernetBlaster, or the ByteBlaster II download cable via the Quartus II software. In addition, many third-party programmers, such as BP Microsystems and System General, offer programming hardware that supports serial configuration devices.

During in-system programming of a serial configuration device via the USB Blaster, EthernetBlaster, or ByteBlaster II download cable, the cable pulls nCONFIG low to reset the FPGA and overrides the 10-k Ω pull-down resistor on the FPGA's nCE pin (refer to [Figure 4-2](#)). The download cable then uses the four interface pins (DATA, nCS, ASDI, and DCLK) to program the serial configuration device. Once the programming is complete, the download cable releases the serial configuration device's four interface pins and the FPGA's nCE pin, and pulses nCONFIG to start configuration.

The FPGA can program the serial configuration device in-system using the JTAG interface with the Serial FlashLoader. This solution allows you to indirectly program the serial configuration device using the same JTAG interface that is used to configure the FPGA.

 For more information about the Serial FlashLoader, refer to *AN 370: Using the Serial FlashLoader with the Quartus II Software*.

 For more information on programming and configuration support, refer to the following documents:

- [Altera Programming Hardware Data Sheet](#)
- [Programming Hardware Manufacturers](#)
- [USB-Blaster Download Cable User Guide](#)
- [ByteBlaster II Download Cable User Guide](#)
- [EthernetBlaster Communications Cable User Guide](#)

Operating Conditions

Table 4-27 through Table 4-31 provide information on absolute maximum ratings, recommended operating conditions, DC operating conditions, and capacitance for serial configuration devices.

Table 4-27. Absolute Maximum Ratings (Note 1)

Symbol	Parameter	Condition	Min	Max	Unit
V_{CC}	Supply voltage for EPCS1, EPCS4, and EPCS16	With respect to ground	-0.6	4.0	V
	Supply voltage for EPCS64 and EPCS128	With respect to ground	-0.2	4.0	V
V_I	DC input voltage for EPCS1, EPCS4, and EPCS16	With respect to ground	-0.6	4.0	V
	DC input voltage for EPCS64 and EPCS128	With respect to ground	-0.5	4.0	V
I_{MAX}	DC V_{CC} or GND current	—	—	15	mA
I_{OUT}	DC output current per pin	—	-25	25	mA
P_D	Power dissipation	—	—	54	mW
T_{STG}	Storage temperature	No bias	-65	150	°C
T_{AMB}	Ambient temperature	Under bias	-65	135	°C
T_J	Junction temperature	Under bias	—	135	°C

Table 4-28. Recommended Operating Conditions

Symbol	Parameter	Conditions	Min	Max	Unit
V_{CC}	Supply voltage	(2)	2.7	3.6	V
V_I	Input voltage	Respect to GND	-0.3	$0.3 + V_{CC}$	V
V_O	Output voltage	—	0	V_{CC}	V
T_A	Operating temperature	For commercial use	0	70	°C
		For industrial use	-40	85	°C
t_R	Input rise time	—	—	5	ns
t_F	Input fall time	—	—	5	ns

Table 4–29. DC Operating Conditions

Symbol	Parameter	Conditions	Min	Max	Unit
V_{IH}	High-level input voltage for EPCS1, EPCS4, and EPCS16	—	$0.6 \times V_{CC}$	$V_{CC} + 0.4$	V
	High-level input voltage for EPCS64 and EPCS128	—	$0.6 \times V_{CC}$	$V_{CC} + 0.2$	V
V_{IL}	Low-level input voltage	—	-0.5	$0.3 \times V_{CC}$	V
V_{OH}	High-level output voltage	$I_{OH} = -100 \mu\text{A}$ (3)	$V_{CC} - 0.2$	—	V
V_{OL}	Low-level output voltage	$I_{OL} = 1.6 \text{ mA}$ (3)	—	0.4	V
I_I	Input leakage current	$V_I = V_{CC}$ or GND	-10	10	μA
I_{OZ}	Tri-state output off-state current	$V_O = V_{CC}$ or GND	-10	10	μA

Table 4–30. I_{CC} Supply Current

Symbol	Parameter	Conditions	Min	Max	Unit
I_{CC0}	V_{CC} supply current (standby) for EPCS1, EPCS4, and EPCS16	—	—	50	μA
	V_{CC} supply current (standby) for EPCS64 and EPCS128	—	—	100	μA
I_{CC1}	V_{CC} supply current (during active power mode) for EPCS1, EPCS4, and EPCS16	—	5	15	mA
	V_{CC} supply current (during active power mode) for EPCS64 and EPCS128	—	5	20	mA

Table 4–31. Capacitance (Note 4)

Symbol	Parameter	Conditions	Min	Max	Unit
C_{IN}	Input pin capacitance	$V_{IN} = 0 \text{ V}$	—	6	pF
C_{OUT}	Output pin capacitance	$V_{OUT} = 0 \text{ V}$	—	8	pF

Notes to Table 4–27 through Table 4–31:

- (1) Refer to the *Operating Requirements for Altera Devices Data Sheet*.
- (2) Maximum V_{CC} rise time is 100 ms.
- (3) The I_{OH} parameter refers to high-level TTL or CMOS output current; the I_{OL} parameter refers to low-level TTL or CMOS output current.
- (4) Capacitance is sample-tested only at $T_A = 25 \times \text{C}$ and at a 20-MHz frequency.

Pin Information

As shown in Figure 4–20 and Figure 4–21, the serial configuration device is an 8-pin or 16-pin device. The control pins on the serial configuration device are: serial data output (DATA), active serial data input (ASDI), serial clock (DCLK), and chip select ($\overline{\text{nCS}}$). Table 4–32 shows the serial configuration device's pin descriptions.

Figure 4–20 shows the Altera serial configuration device 8-pin SOIC package and its pin-out diagram.

Figure 4–20. Altera Serial Configuration Device 8-Pin SOIC Package Pin-Out Diagram

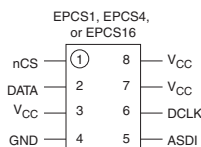
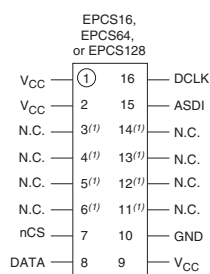

Figure 4–21 shows the Altera serial configuration device 16-pin SOIC package and its pin-out diagram.

Figure 4–21. Altera Serial Configuration Device 16-Pin SOIC Package Pin-Out Diagram



Note to Figure 4–21:

(1) These pins can be left floating or connected to V_{CC} or GND, whichever is more convenient on the board.

Table 4–32. Serial Configuration Device Pin Description (Part 1 of 2)

Pin Name	Pin Number in 8-Pin SOIC Package	Pin Number in 16-Pin SOIC Package	Pin Type	Description
DATA	2	8	Output	The DATA output signal transfers data serially out of the serial configuration device to the FPGA during read/configuration operation. During a read/configuration operations, the serial configuration device is enabled by pulling nCS low. The DATA signal transitions on the falling edge of DCLK.
ASDI	5	15	Input	The AS data input signal is used to transfer data serially into the serial configuration device. It receives the data that should be programmed into the serial configuration device. Data is latched on the rising edge of DCLK.
nCS	1	7	Input	The active low chip select input signal toggles at the beginning and end of a valid instruction. When this signal is high, the device is deselected and the DATA pin is tri-stated. When this signal is low, it enables the device and puts the device in an active mode. After power up, the serial configuration device requires a falling edge on the nCS signal before beginning any operation.

Table 4-32. Serial Configuration Device Pin Description (Part 2 of 2)

Pin Name	Pin Number in 8-Pin SOIC Package	Pin Number in 16-Pin SOIC Package	Pin Type	Description
DCLK	6	16	Input	DCLK is provided by the FPGA. This signal provides the timing of the serial interface. The data presented on ASDI is latched to the serial configuration device on the rising edge of DCLK. Data on the DATA pin changes after the falling edge of DCLK and is latched into the FPGA on the next falling edge.
V _{CC}	3, 7, 8	1, 2, 9	Power	Power pins connect to 3.3 V.
GND	4	10	Ground	Ground pin.

As shown in [Figure 4-20](#) and [Figure 4-21](#), the serial configuration device is an 8-pin or 16-pin device. In order to take advantage of vertical migration from EPSCS1 to EPCS128, Altera recommends a layout for serial configuration devices.

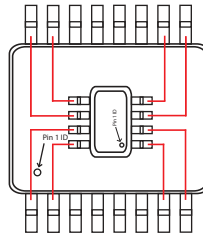
Figure 4-22. Layout Recommendation for Vertical Migration from EPCS1 to EPCS128**Table 4-33.** Pin Number for 8-pin SOIC Package

Pin Name	SOIC 8	SOIC 16
nCS	1	7
DATA	2	8
V _{CC}	3	9
GND	4	10
ASDI	5	15
DCLK	6	16
V _{CC}	7	1
V _{CC}	8	2

Package

EPCS1 and EPCS4 available in 8-pin small outline integrated circuit (SOIC) package. EPCS16 and EPCS128 available in 8-pin and 16-pin small outline integrated circuit (SOIC) packages.



For more information on Altera device packaging including mechanical drawing and specifications for this package, refer to the [Altera Device Package Information Data Sheet](#).

Ordering Code

Table 4–34 shows the ordering codes for serial configuration devices.

Table 4–34. Serial Configuration Device Ordering Codes

Device	Ordering Code (1)
EPCS1	EPCS1SI8
	EPCS1SI8N
EPCS4	EPCS4SI8
	EPCS4SI8N
EPCS16	EPCS16SI16N
	EPCS16SI8N
EPCS64	EPCS64SI16N
EPCS128	EPCS128SI16N

Note to Table 4–34:

(1) N: Lead free.

Referenced Documents

This chapter references the following documents:

- [Active Serial Memory Interface Data Sheet](#)
- [Altera Device Package Information Data Sheet](#)
- [Altera Programming Hardware Data Sheet](#)
- [AN 370: Using the Serial FlashLoader with the Quartus II Software](#)
- [AN 418: SRunner: An Embedded Solution for Serial Configuration Device Programming User Guide](#)
- [ByteBlaster II Download Cable User Guide](#)
- [Configuring Cyclone III Devices](#) chapter in volume 1 of the [Cyclone III Device Handbook](#)
- [EthernetBlaster Communications Cable User Guide](#)
- [Operating Requirements for Altera Devices Data Sheet](#)
- [Programming Hardware Manufacturers](#)
- [USB-Blaster Download Cable User Guide](#)

Document Revision History

Table 4-35 shows the revision history for this chapter.

Table 4-35. Document Revision History (Part 1 of 2)

Date and Revision	Changes Made	Summary of Changes
October 2008, version 3.2	<ul style="list-style-type: none"> ■ Updated “Introduction”, “Active Serial FPGA Configuration”, “Operation Codes”, “Read Status Operation”, “Read Device Identification Operation”, and “Package” sections. ■ Updated Table 4-10, Table 4-25, Table 4-26, and Table 4-32. ■ Updated Figure 4-5, Figure 4-13, and Figure 4-19. ■ Added Figure 4-22. ■ Added Table 4-33. ■ Updated new document format. 	—
May 2008, version 3.1	<ul style="list-style-type: none"> ■ Updated Table 4-3, Table 4-6, Table 4-7, Table 4-28, and Table 4-29. ■ Deleted Note 5 to Table 4-31. ■ Added “Referenced Documents” section. 	—
August 2007, version 3.0	<ul style="list-style-type: none"> ■ Updated “Introduction” section. ■ Updated “Functional Description” section. ■ Updated Table 4-1 through Table 4-4 and Table 4-7 through Table 4-9 to with EPCS128 information. ■ Added Table 4-6 on Arria GX. ■ Added notes to Figure 4-3. ■ Added notes to Figure 4-4. ■ Updated Table 4-10 with EPCS128 information. ■ Added new Table 4-11 on address range for sectors in EPCS128 device. ■ Updated Table 4-16 with information on “Read Device Identification” and added (Note 5). ■ Added new Table 4-21 on block protection bits in EPCS128. ■ Added notes to Figure 4-12. ■ Added new section “Read Device Identification Operation” with Table 4-23 and Figure 4-13. ■ Updated “Write Bytes Operation”, “Erase Bulk Operation” and “Erase Sector Operation” sections. ■ Updated Table 4-24 to include EPCS128 information. ■ Updated (Note 1) to Table 4-26. ■ Updated V_{CC} and V_I information to include EPCS128 in Table 4-27. ■ Updated V_{IH} information to include EPCS128 in Table 4-29. ■ Updated I_{CC0} and I_{CC1} information to include EPCS128 in Table 4-30. ■ Updated Figure 4-21 and Table 4-34 with EPCS128 information. 	<ul style="list-style-type: none"> ■ Updated document to include EPCS128. ■ Updated document to include Arria GX.

Table 4-35. Document Revision History (Part 2 of 2)

Date and Revision	Changes Made	Summary of Changes
April 2007, version 2.0	<ul style="list-style-type: none"> ■ Updated “Introduction” section. ■ Updated “Functional Description” section and added handpara note. ■ Added Table 4-4, Table 4-6, and Table 4-7. ■ Updated “Active Serial FPGA Configuration” section and its handpara note. ■ Added notes to Figure 4-2. ■ Updated Table 4-26 and added (Note 1). ■ Updated Figure 4-20. ■ Updated Table 4-34. 	<ul style="list-style-type: none"> ■ Updated chapter to include Stratix II GX, Stratix III, and Cyclone III support for EPCS devices. ■ Added information about EPCS16SI8N.
January 2007, version 1.7	<ul style="list-style-type: none"> ■ Removed reference to PLMSEPC-16 in “Programming and Configuration File Support”. ■ Updated DCLK pin information in Table 4-32. 	—
October 2006, version 1.6	<ul style="list-style-type: none"> ■ Updated Figure 4-19. ■ Updated Table 4-30 and Table 4-32. 	—
August 2005, version 1.5	<ul style="list-style-type: none"> ■ Updated table 4-4 to include EPCS64 support for Cyclone devices. 	—
August 2005, version 1.4	<ul style="list-style-type: none"> ■ Updated tables. ■ Minor text updates. 	—
February 2005, version 1.3	<ul style="list-style-type: none"> ■ Updated hot socketing AC specifications. 	—
October 2003, version 1.2	<ul style="list-style-type: none"> ■ Added Serial Configuration Device Memory Access section. ■ Updated timing information in Tables 4-10 and 4-11 section. ■ Updated timing information in Tables 4-16 and 4-17. 	—
July 2003, version 1.1	<ul style="list-style-type: none"> ■ Minor updates. 	—
May 2003, version 1.0	<ul style="list-style-type: none"> ■ Added document to the <i>Cyclone Device Handbook</i>. 	—

